

IOT BASED AIR POLLUTION MONITORING SYSTEM

Sanskruti Zod¹, Sakshi Mugal², Bhavika Sawai³, Shubham Kawale⁴, Harsh Dube⁵,
R. M. Gharat⁶

^{1,2,3,4,5}Student, Electronics Engineering, Dr. Panjabrao. Deshmukh Polytechnic Amravati, Maharashtra, India.

⁶R. M. Gharat Head of Electronic Engineering Department, Dr. Panjabrao. Deshmukh Polytechnic Amravati, Maharashtra, India.

DOI: <https://www.doi.org/10.58257/IJPREMS33414>

ABSTRACT

Every vehicle has its emission of gases, but the difficulty is the emission of the gas outside the uniform values. This emission from the vehicles cannot be completely avoided, but in certain things, we can be able to control this. In this situation, in most countries, air pollution is a major problem. In our life there are three needed necessities are used on earth i.e., air, liquid substances (water), solid substances (food). Before it consumed the water, the water permits through a reliable cleaning process. From the statistics, without significant weather, the air polluted or not, living beings that breathe over 3000 tons of air per day. Therefore, this suggests raising awareness to the public regarding air quality and air pollutants. Because of air pollution not only human health is affected it also damages the atmosphere and surroundings so decrease the mature of live hood.

Keywords: - Internet of Things, Arduino UNO, Air pollution, Gas sensor, Arduino IDE.

1. INTRODUCTION

Air pollution has a diversified harmful effect on human beings. The changes occurring in the environment and weather have hostile results on flora and fauna. The main reason for the cause of air pollution is the excessive use of energy resources such as natural calamities like volcanic eruptions and forest fires which pollute the air, but the occurrence is less. Hence there is an increase in the level of pollutants in the air as there is a release of pollutants in air. Most countries in Asia are highly influenced by highly concentrated flammable gases. The major air pollutants accountable for affecting human health are smoke and carbon monoxide, Sulfur dioxide, nitrogen monoxide, nitrogen dioxide, and many more. But in recent scenarios, IoT has profoundly overtaken the situation in control as it is used in pollution monitoring systems, e-health, smart cities, etc. Internet of things (IoT) interconnects devices, and the connected devices can communicate wirelessly. It mainly consists of sensors, processors, a connectivity, and a cloud server, whereas sensors use to sense the required information of various air pollutants The processor processes the sensed data from the sensor and communicates it to the server using the internet. And the whole process of sensing the required information, communicating the information securely and efficiently done with the help of the internet, analyzing data, and then taking appropriate action, which can be like shutting down the engine, are some of the main tasks performed.

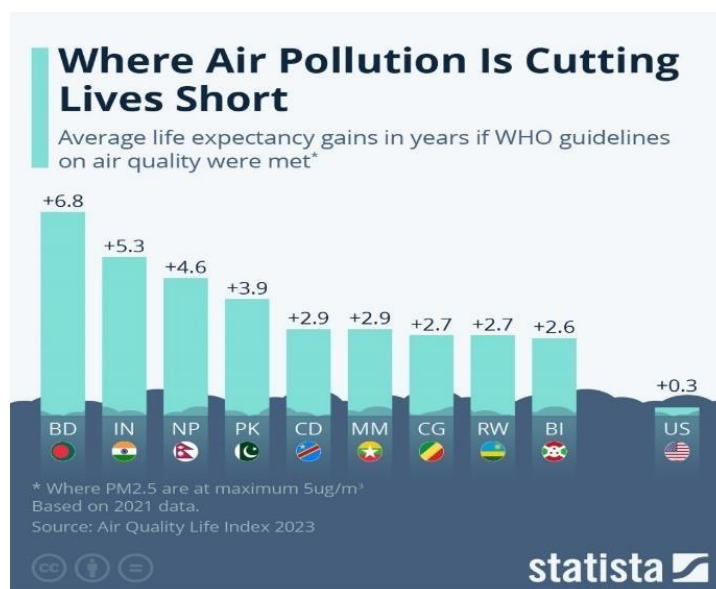

Fig No-1: Air Quality Life Index 2023

2. LITERATURE SURVEY

The wireless standard was used to design, build, and observe an Air Pollution Monitoring System for monitoring the combination of key air pollutant gases. Using semiconductor sensors, this device measures a mixture of hazardous gases. A single-chip microprocessor, an array of air pollution sensors, a GSM-Module, and a GPS Module are all included in the hardware unit. The Central-Server is an internet-connected high-end personal computer application server. The hardware collects air pollution levels and stores them in a frame that includes the GPS physical location, time, and data.

- 1. Chourey, Pet et al. (2022)** (1) Designed IoT based air pollution monitoring system using MQ135, MQ7, and DHT11 gas sensors. These sensors will respond to the esp32 module, which will show the information on the Think Speak web server and configure a buzzer to notify us if the air quality drops below the set value.
- 2. Saiye, Y.D. et al. (2020)** (2) Designed air quality detection and monitoring system employs a wireless sensor network to monitor air quality in various places while also producing near real-time information and data that can be retrieved via smartphones, tablets and internet compatible device. Designed system that can track the number of contaminants in the air developed by using Arduino Uno, a WIFI module, and a MQ135 gas sensor.
- 3. Harsh Gupta and colleagues (2019)** (3) Developed an IoT based air pollution monitoring system for smart cities. Smart cities are under pressure to stay livable as the world's population becomes more urbanized. The air quality of urban centers has become a prominent source of worry around the world in recent years. As a result, in order to make a city smart and livable, it is vital to regularly evaluate its air quality index. We propose and construct an IoT-based Air Quality Monitoring System for Smart Cities in this research. Air quality data is retrieved in real time via smart devices and analyzed to determine the influence on city people.
- 4. Harsh N. Shah and colleagues et al. (2018)** (4) Developed IOT based air pollution monitoring system using ATmega328P, Wi-Fi module ESP8266, MQ135 Gas sensor, MQ 6 LPG gas sensor, LM35 temperature sensor and humidity sensor SY-H5220. The Internet of Things-based Air Pollution Monitoring System is used to monitor the air quality via a web server. It will sound an alert if the air quality falls below a particular threshold, which signifies there are enough dangerous gases in the air, such as CO₂, smoking, alcohol, benzene, NH₃, and NO_x. It will display the air quality in PPM on the LCD as well as on the webpage, allowing for easy monitoring of air pollution.
- 5. Patil, P. et al. (2017)** (5) Developed smart IoT based system for vehicle noise and pollution monitoring. The hardware architecture as well as the software implementation are thoroughly detailed. IoT technology is also used to verify the system's performance. The clever intelligent environmental system that was built monitors the pollutants produced by automobiles and alerts vehicle owners to take action to reduce pollution. The data on pollution levels is also sent to a server for further study. Air pollution authorities can examine data and identify car registration numbers that contribute to increased pollution in the atmosphere. The designed system is low-cost, easy-to-use, and may be placed in any location. The created system outperforms the old system in terms of accuracy and cost.
- 6. Monika Singh Et al. in August 2019** (6) Proposed an Air Pollution Monitoring System. This system uses an Arduino microcontroller connected with MQ135 and MQ6 gas sensor which senses the different types of gases present in the environment. It was then connected to the Wi-Fi module which connects to the internet and LCD is used to display the output to the user and buzzer alerts when the ppm crosses certain limit. Their applications were industrial perimeter monitoring, indoor air quality monitoring, site selection for reference monitoring stations, making data available to users.
- 7. Yamunathangam Et al. in November 2018** (7) Used IoT by measuring the concentration of gas using various sensors which were observed through serial monitor of Arduino. This data is collected in Thing speak channels by means of Ethernet shield which is available in live for further processing. These analyzed results were viewed through thing speak in a graphical format. Then the average pollution level was calculated using MATLAB analysis and the time controlled results were viewed through an android app. Further based on the location, the air quality index value was obtained through the android app. Along with this, the health effects were also displayed in this app, so that the users can stay aware of the pollution levels.

3. METHODOLOGY

In the contemporary era, global air pollution stands out as a formidable concern, exacerbated by the escalating use of vehicles, rapid industrialization, and expansive urbanization. The deleterious impact of these factors on human well-being is evident, as the atmosphere becomes laden with harmful gasses such as carbon dioxide, smoke, alcohol, benzene, NH₃, and NO₂. The decline in air quality poses a substantial threat to both human health and the environment, necessitating the development of innovative solutions for the monitoring and management of air quality. As we grapple with the

consequences of increased pollution levels, there emerges a critical need for a sophisticated system that can comprehensively assess and address the intricate dynamics of air quality in real-time. Introducing a pioneering initiative, this project puts forth an Internet of Things (IoT) based system meticulously crafted to monitor air quality on a holistic scale. The system is engineered to detect and quantify a diverse array of pollutants, ranging from carbon dioxide to NO₂, offering a nuanced understanding of the atmospheric composition. Real-time data presentation becomes a cornerstone of this endeavor, providing users with immediate insights into the prevailing air quality conditions. Beyond mere data display, the system employs an innovative approach to categorizing air quality, allowing for a nuanced assessment that goes beyond conventional labels of "good" or "bad". Furthermore, this project goes beyond conventional monitoring systems by incorporating a unique feature towards sustainability. Recognizing the pivotal role of trees in environmental equilibrium, the system recommends the planting of trees as an eco-friendly strategy to mitigate pollution levels. This multifaceted approach not only addresses the immediate concern of air quality but also aligns with broader initiatives aimed at fostering environmental consciousness and sustainability in the face of escalating global challenges.

BLOCK DIAGRAM AND EXPLANATION

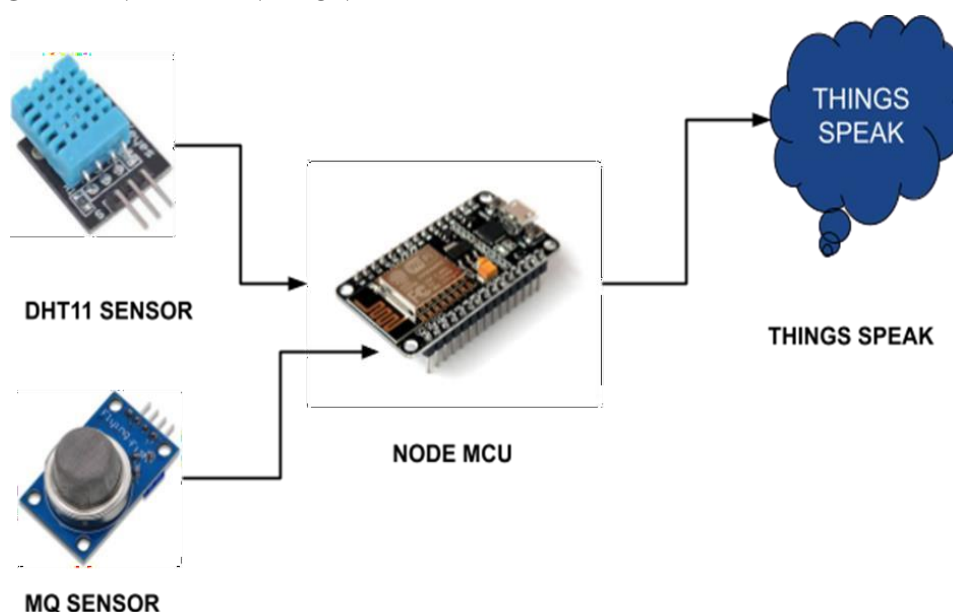

Fig No-2: Block Diagram

DESCRIPTION: -

In the block diagram we have used the NodeMCU as a microcontroller and a DHT11 sensor, MQ sensor in the input device. And in the output device we have used the IOT server connected to the microcontroller. And we have used the Thing Speak app to show all the notifications.

Page | 4

INPUT DEVICES: -

NodeMCU (Microcontroller): - Serves as the central processing unit. It is likely Programmed to read data from connected sensors, process the information, and facilitate communication with the IOT server.

DHT11 Sensor: - Measures temperature and humidity in the environment. This data provides crucial information about the atmospheric conditions, which can affect air quality and MQ Gas Sensor: Measures the concentrations of various gasses such.

- carbon dioxide (CO₂)
- carbon monoxide (CO)
- sulfur dioxide (SO₂)
- nitrogen dioxide (NO₂)
- ozone (O₃)

MICROCONTROLLER PROCESSING: -

The NodeMUC processes the data from the DTH11 and MQ sensors. It likely involves calibration, conversion, and filtering of sensor data to ensure accuracy.

OUTPUT DEVICES: -

IoT Server: - This is where the processed data is sent. The IOT server plays a crucial role in aggregating and managing the data received from multiple devices. It may perform additional processing and storage functions.

Thing Speak App: - Acts as the user interface. Users can access real-time data, historical records, and receive alerts based on predefined air quality thresholds. The app likely visualizes the data in an understandable format, such as graphs or charts.

COMMUNICATION: -

The NodeMCU communicates with both the DHT11 and MQ sensors to collect environmental data. And the NodeMCU also communicates with the IOT server to send the processed data. This communication is likely achieved through the internet, given the IOT nature of the system.

HARDWARE COMPONENTS

Node MCU ESP8266.



Fig No-3: Node MCU ESP8266

The Node MCU (Node Microcontroller Unit) is an open source software and hardware development environment that is built around a very inexpensive System-on-a-Chip (SoC) called the ESP8266. The ESP8266, designed and manufactured by Express if Systems, contains all crucial elements of the modern computer: CPU, RAM, networking (Wi-Fi), and even a modern operating system and SDK. When purchased at bulk, the ESP8266 chip costs only 450/-INR a piece. That makes it an excellent choice for IoT projects of all kinds. Through its pins we can read inputs - light on a sensor, a finger on a button, or a Twitter message - and turn them into an output - activating a motor, turning on an LED, publishing something online. It has also Wi-Fi capabilities, so we can control it wirelessly and make it work on a remote installation easily! We can tell our board what to do by sending a set of instructions to the microcontroller on the board. To do so we can use the the Arduino Software (IDE). Power Pins There are four power pins. VIN pin and three 3.3V pins. VIN can be used to directly supply the NodeMCU/ESP8266 and its peripherals. Power delivered on VIN is regulated through the onboard regulator on the NodeMCU module – you can also supply 5V regulated to the VIN pin. 3.3V pins are the output of the onboard voltage regulator and can be used to supply power to external components. GND are the ground pins of NodeMCU/ESP8266 I2C Pins are used to connect I2C sensors and peripherals. Both I2C Master and I2C Slave are supported. I2C interface functionality can be realized programmatically, and the clock frequency is 100 kHz at a maximum. It should be noted that I2C clock frequency should be higher than the slowest clock frequency of the slave device. GPIO Pins NodeMCU/ESP8266 has 17 GPIO pins which can be assigned to functions such as I2C, I2S, UART, PWM, IR Remote Control, LED Light, and Button programmatically. Each digital enabled GPIO can be configured to internal pull-up or pull-down or set to high impedance. When configured as an input, it can also be set to edge-trigger or level-trigger to generate CPU interrupts. ADC Channel the NodeMCU is embedded with a 10-bit precision SAR ADC. The two functions can be implemented using ADC. Testing power supply voltage of VDD3P3 pin and testing input voltage of TOUT pin. However, they cannot be implemented at the same time. ART Pins NodeMCU/ESP8266 has 2 UART interfaces (UART0 and UART1) which provide asynchronous communication (RS232 and RS485), and can communicate at up to 4.5 Mbps. UART0 (TXD0, RXD0, RST0 & CTS0 pins) can be used for communication.

Gas Sensor MQ135



Fig No-4: Gas Sensor MQ135

The Gas Sensor (MQ2) component is used for the gas leakage finding. It is used for recognizing LPG Liquefied petroleum gas, CH₄, CO (carbon monoxide), Smoke. The circuit is very simple. Gas sensor of the MQ-2 gas sensor is SnO₂ (stannic oxide), which with lesser conductivity in clean air. MQ2 gas sensor is an electronic sensor used for sensing the concentration of gases in the air such as LPG, propane, methane, hydrogen, alcohol, smoke, and carbon monoxide. MQ2 gas sensor is also known as chemiresistor. It contains a sensing material whose resistance changes when it comes in contact with the gas. This change in the value of resistance is used for the detection of gas. MQ2 is a metal oxide semiconductor type gas sensor. Concentrations of gas in the gas is measured using a voltage divider network present in the sensor. This sensor works on 5V DC voltage. It can detect gasses in the concentration of 200 to 10000ppm. This sensor contains a sensing element, mainly aluminum-oxide based ceramic, coated with Tin dioxide, enclosed in a stainless-steel mesh. Sensing element has six connecting legs attached to it. Two leads are responsible for heating the sensing element, the other four are used for output signals. Oxygen gets adsorbed on the surface of sensing material when it is heated in air at high temperature. Then donor electrons present in tin oxide are attracted towards this oxygen, thus preventing the current flow. When reducing gasses are present, these oxygen atoms react with the reducing gasses thereby decreasing the surface density of the adsorbed oxygen. Now current can flow through the sensor, which generates analog voltage values. These voltage values are measured to know the concentration of gas. Voltage values are higher when the concentration of gas is high.

DHT11 Sensor

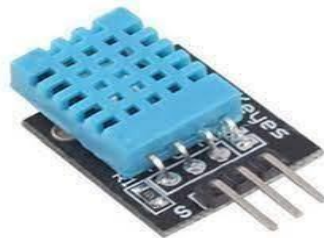

Fig No-5: DHT11 Sensor

DHT11 is featured to measure temperature and humidity sensor complex by using temperature & humidity sensing technique with output in the form of the standardized digital. DHT11 is a Humidity and Temperature Sensor, which generates calibrated digital output. DHT11 can interface with any microcontroller like Arduino, Raspberry Pi, etc. and get instantaneous results. DHT11 is a low-cost humidity and temperature sensor which provides high reliability and long-term stability. It uses a capacitive humidity sensor and a thermistor to measure the surrounding air, and outputs a digital signal on the data pin (no analog input pins needed). It's very simple to use, and libraries and sample codes are available for Arduino and Raspberry Pi. This module makes it easy to connect the DHT11 sensor to an Arduino or microcontroller as it includes the pull up resistor required to use the sensor. Only three connections are required to be made to use the sensor Vcc, Gnd and Output. It has high reliability and excellent long-term stability, thanks to the exclusive digital signal acquisition technique and temperature & humidity sensing technology.

16x2 LCD Display

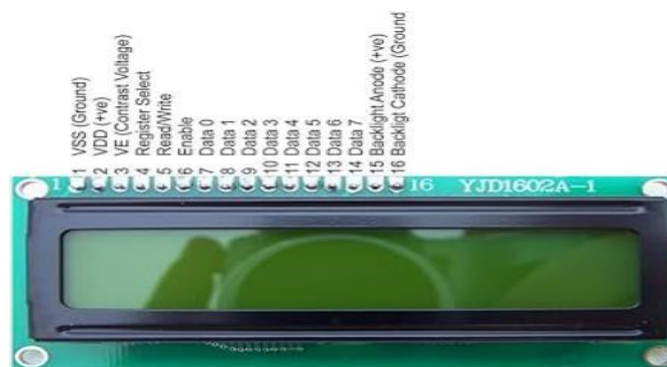

Fig No-6: 16x2 LCD Display

A 16x2 LCD display is a liquid crystal display that can show 16 characters in each of its two rows, providing a total of 32 characters of information. It's commonly used to display alphanumeric information in various electronic devices. A 16x2 LCD display works by controlling the liquid crystals to either block or allow light to pass through, creating characters and symbols on the screen. It's controlled by sending data and commands to its controller, which in turn manages the display of information. A standard 16x2 LCD display has 16 pins, typically organized into two rows of eight pins each. These pins are used for power supply, data communication, and control signals the contrast control

adjusts the contrast between the text and the background on the LCD screen. By changing the voltage across the liquid crystals, you can control the readability of the displayed content. A 16×2 LCD display can display a wide range of information, including text, numbers, symbols, and basic graphics. It's often used to display status information, menu options, sensor readings, and more.

SOFTWARE REQUIREMENTS

Thing Speak

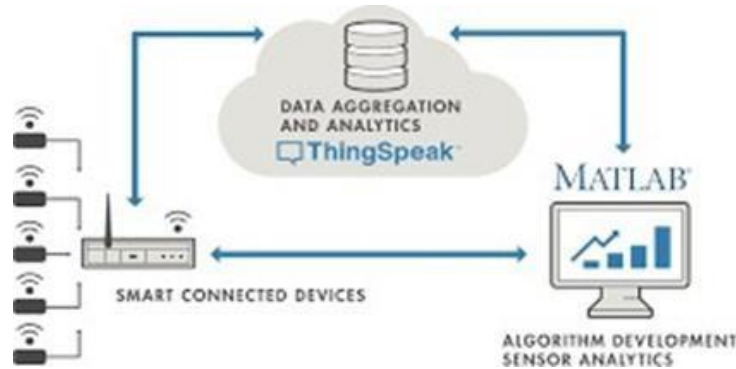

Fig No-7: Thing Speak

Thing Speak is an IoT analytics platform service that allows you to aggregate, visualize, and analyze live data streams in the cloud. You can send data to Thing Speak™ from your devices, create instant visualizations of live data, and send alerts using web services like Twitter® and Twilio®. With MATLAB® analytics inside Thing Speak, you can write and execute MATLAB code to perform preprocessing, visualizations, and analyses. Thing Speak enables engineers and scientists to prototype and build IoT systems without setting up servers or developing web software. Thing Speak is a platform providing various services exclusively targeted for building IoT applications. It offers the capabilities of real-time data collection, visualizing the collected data in the form of charts, ability to create plugins and apps for collaborating with web services, social network and other APIs. We will consider each of these features in detail below. The core element of Thing Speak is a 'Thing Speak Channel'. A channel stores the data that we send to Thing Speak and comprises of the below elements:

- 8 fields for storing data of any type - These can be used to store the data from a sensor or from an embedded device.
- 3 location fields - Can be used to store the latitude, longitude and the elevation. These are very useful for tracking a moving device.
- 1 status field - A short message to describe the data stored in the channel.

Arduino IDE



Fig No-9: Arduino IDE

The development of electronics is now easier thanks to Arduino software (IDE), and Arduino boards (hardware). This set helps to build digital and interactive devices with the help of other components. The Arduino software (IDE) is an open-source software, which is used to program the Arduino boards, and is an integrated development environment,

developed by arduino.cc. Allow to write and upload code to Arduino boards. And it consisted of many libraries and a set of examples of mini projects. Arduino software (IDE) is compatible with different operating systems (Windows, Linux, Mac OS X), and supports the programming languages (C/C++) The Arduino software is easy to use for beginners, or advanced users. It uses to get started with electronics programming and robotics and build interactive prototypes. So, Arduino software is a tool to developed new things. and create new electronic projects, by Anyone children, hobbyists, engineers, programmers etc. Menus are the main menus of the program, and they are 5 menus (File, Edit, Sketch, Tools, Help), and they are being used to add or modify the code that you are writing. The toolbar is the most important section in the Arduino software, because it contains the tools that you will use continuously while programming the Arduino board. Code editor is liberator of codes, is the white space in the program, in which codes are been writing, and modifying on it. Program notifications this program showing you the mistakes of codes, and some problems that can be face you during the programming process. And clarifies to you the type of the mistake or the problem which happened and it presents some instruction through it, which you have to apply to process the mistake or the problem. Serial ports selections is a space in which the program showing you the type of the port which is used to connect the Arduino by computer. Board selections is a space in which the program showing you the type of the Arduino board.

APPLICATIONS OF PROJECT

Environmental Monitoring: The system is vital for environmental agencies and organizations that aim to monitor air quality to assess the impact of human activities, industrial emissions, and natural factors on the environment.

Agriculture: In agriculture, the system can be employed to monitor air quality in rural areas. This is particularly relevant for assessing the impact of air pollution on crops and soil health.

Healthcare: The healthcare sector can utilize the system to monitor air quality in hospitals, clinics, and other healthcare facilities. This is particularly important for patients with respiratory conditions, as it allows for timely interventions when air quality deteriorates.

Industrial Monitoring: Industries can integrate this system into their operations to monitor and manage emissions. It helps industries comply with environmental regulations and ensures a safer working environment for employees.

Research and Academic Institutions: Researchers and academic institutions can leverage the system for studies related to air pollution patterns, sources of pollution, and the effectiveness of pollution control measures. It serves as a valuable tool for scientific research and analysis.

Government and Policy Implementation: Government agencies responsible for environmental protection and public health can use the system to enforce regulations, implement policies, and take preventive measures based on real-time air quality data.

Community Initiatives: Local communities can deploy the system to monitor air quality in their neighborhoods. This grassroots approach can empower communities to address pollution concerns, advocate for cleaner air, and engage in local environmental initiatives.

Urban Planning and Smart Cities: In urban areas and smart city initiatives, the system can be employed to gather real time data on air pollution levels. This information can aid city planners in making informed decisions regarding infrastructure development and pollution control measures.

A COMPLETE HARDWARE SYSTEM SETUP

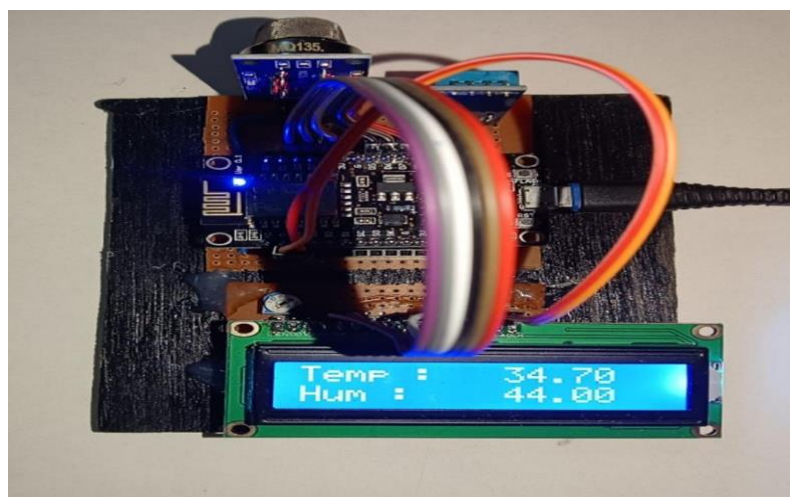

Fig No-10: Complete Hardware System Setup

Observations in Thing Speak Cloud

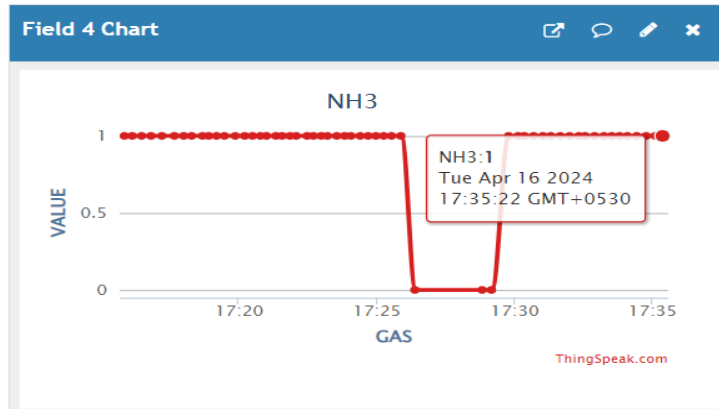

Fig No-11: Ammonia

In this above figure we show graphical representation of NH₃ it is called as ammonia also. in this graphical representation on a Y-AXIS, we show the value of NH₃(Ammonia) gas & on a X-AXIS we can shows the time representation also. The concentration at which the gas is immediately harmful to life or health (IDLH) is 300 ppm. There is minimal absorption of ammonia into the systemic circulation if there is short-term (under 120 seconds) inhalational exposure. Most of the inhaled ammonia gets dissolved in the mucus of the upper respiratory tract, and 70% to 80% gets excreted in the exhaled air.

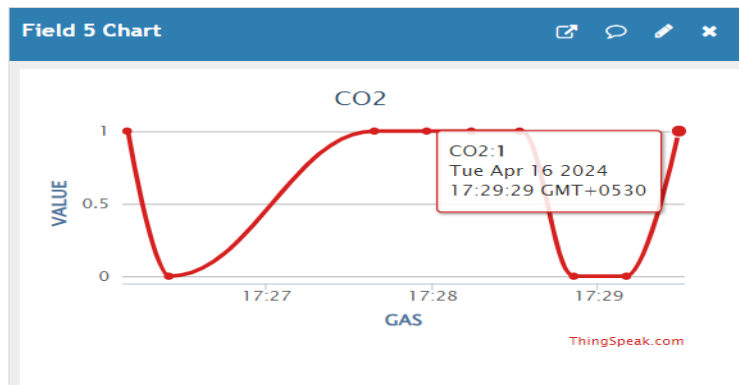

Fig No-12: Carbon dioxide

In this above figure we show graphical representation of CO₂ it is called Carbon dioxide also. in this graphical representation on a Y-AXIS, we show the value of CO₂ (Carbon dioxide) gas& on a X-AXIS we can shows the time representation also. Occupants may experience health effects in buildings where CO₂ is elevated, but the symptoms are usually due to the other contaminants in the air that also build up as a result of insufficient ventilation. At high levels, the carbon dioxide itself can cause headache, dizziness, nausea and other symptoms. This could occur when exposed to levels above 5,000 ppm for many hours. At even higher levels of CO₂ can cause asphyxiation as it replaces oxygen in the blood-exposure to concentrations around 40,000 ppm is immediately dangerous to life and health. CO₂ poisoning, however, is very rare.

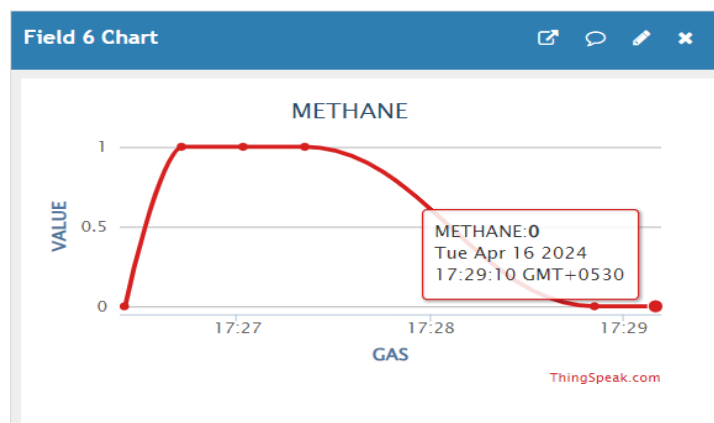

Fig No-13: Methane

In this above figure we show graphical representation of CH₄ it is called Methane. In this graphical representation on a Y-AXIS, we show the value of CH₄(Methane) gas & on a X- AXIS we can show the time representation also. at a 2.000 ppm range of methane A high concentration can displace oxygen in the air. If less oxygen is available to breathe, symptoms such as rapid breathing, rapid heart rate, clumsiness, emotional upsets and fatigue can result. As less oxygen becomes available, nausea and vomiting, collapse, convulsions, coma and death can occur. Symptoms occur more quickly with physical effort. Lack of oxygen can cause permanent damage to organs including the brain and heart.

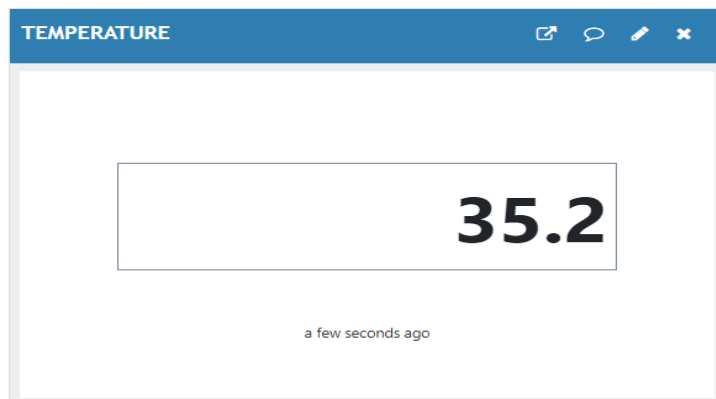

Fig No-14: Temperature

In this above figure we can show the temperature level present in our atmosphere by using IoT-based air pollution monitoring system & Thing Speak IoT analytics platform service also. Researchers investigated when the body starts exerting more energy to keep itself cool at high temperatures. They found that this upper-temperature limit lies between 40°C (104F) and 50°C (122F) when the human body stops functioning optimally.

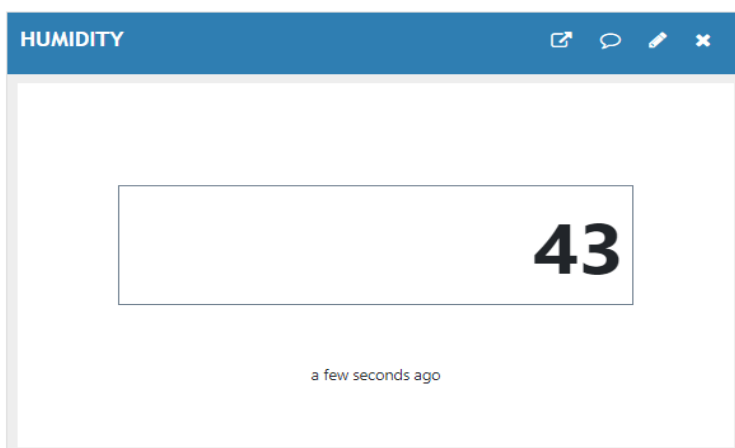

Fig No-15: Humidity

In this above figure we can show the humidity level present in our atmosphere by using IoT-based air pollution monitoring system & Thing Speak IoT analytics platform service also.

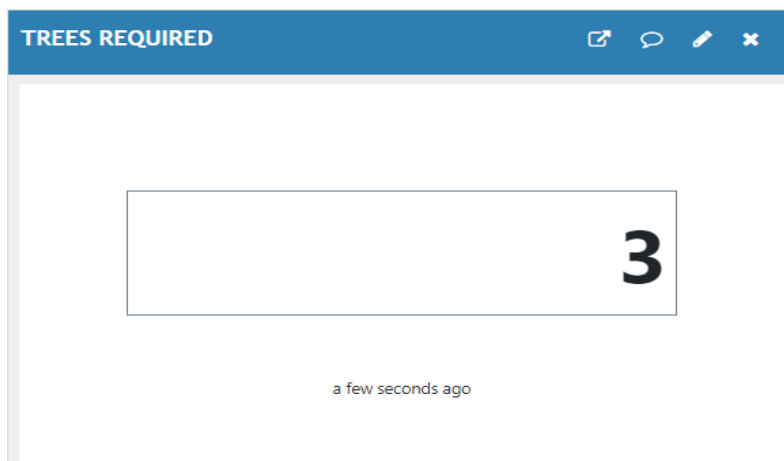

Fig No-16: Trees Required

4. CONCLUSIONS

In conclusion, the IoT-based air pollution monitoring system offers a comprehensive and innovative solution to address the pressing challenges posed by air pollution. By continuously monitoring a wide range of pollutants, providing real-time data, and suggesting tree planting as a proactive pollution control measure, the system not only enhances public health and environmental sustainability but also empowers individuals and communities to take informed actions towards a cleaner and healthier future.

5. REFERENCES

- [1] Chourey, P., Soni, K., Singh, N.J. and Agarwal, R., 2022. IoT-Sodar Network for Airshed Management Planning. IETE Journal of Research, pp.1-15.
- [2] Saiye, Y.D. and Ajose-Ismail, B.M., 2020. IoT Based Air Quality Detection and Monitoring System. International Journal of Research and Innovation in Applied Science, 5(7), pp.6.
- [3] Gupta, H., Bhardwaj, D., Agrawal, H., Tikki Wal, V.A. and Kumar, A., 2019, February. An IoT based air pollution monitoring system for smart cities. In 2019 IEEE International Conference on Sustainable Energy Technologies and Systems (ICSETS) (pp. 173-177). IEEE.
- [4] Harsh N. Shah 1, Zishan Khan 2, Abbas Ali Merchant 3, Moin Moghul 4, Aamir Shaikh 5, Priti Rane 6, "IoT Based Air Pollution Monitoring System", International Journal of Scientific & Engineering Research Volume 9, Issue 2, February-2018 ISSN 2229-5518, 1, 2, 3, 4,5 Student, Diploma in Computer Engineering, BGIT, Mumbai Central, India 6 Assistant Professor, BGIT, Mumbai Central, India.
- [5] Patil, P., 2017, May. Smart IoT based system for vehicle noise and pollution monitoring. In 2017 International Conference on Trends in Electronics and Informatics (ICEI) (pp. 322-326). IEEE.
- [6] Monika Singh, Misha Kumari, Pradeep Kumar Chauhan, (2019) 'IoT Based Air Pollution Monitoring System using Arduino', International Research Journal of Engineering and Technology, IRJET.
- [7] Yamunathangam, K. Prit Heka, P. Varuna, (2018) 'IoT Enabled Air Pollution Monitoring and Awareness Creation System', International Journal of Recent Technology and Engineering, IRJET.